



MiraTEC was conceived and engineered to resist moisture, rot and termites, so it is perfect for exterior non-structural applications. It handles like wood and is reversible. MiraTEC has an authentic woodgrain texture on one side and a smooth surface on the other; MiraTEC 1-1/4" actual thickness (6/4 nominal) is smooth on both sides. Plus, MiraTEC is building code compliant in the U.S. (ESR-3043 from the ICC-ES), Florida Building Code 22271, and in Canada (CCMC 14015-L from the Canadian Construction Materials Centre).*

We make every effort to ensure that MiraTEC trim meets our quality standards. It is important to read all the following installation and maintenance instructions prior to installation. Please note: failure to comply with the following installation and maintenance instructions will impact the full benefit of the 50-Year Limited Warranty. For specific questions related to these installations, please email support@miratecextira.com.

CUTTING:

- Use a fine-tooth hand saw or power saw with a combination blade.
- Cut into the exposed face of the material.
- Carbide-tipped blades are recommended.

FASTENING REQUIREMENTS:

MiraTEC trim is a non-structural decorative trim product and should not be used where structural lumber properties are required. MiraTEC trim is designed to be applied to structural framing, sheathing and other materials.

***Note: Nail at least 1/2" from the edge. Do not nail into the edges of MiraTEC trim. For 3/4" (4/4) and 1" (5/4) fascia and soffit applications, MiraTEC trim can be fastened directly to the rafter ends, double nailed a maximum of 24" on center. For 5/8" fascia and soffit applications, MiraTEC trim must have a sub-fascia and be nailed 16" on center to the rafter ends or sub-fascia. For all other horizontal and vertical applications, double nail 16" on center, falling on the studs.**



DO NOT nail toward the center from both ends.

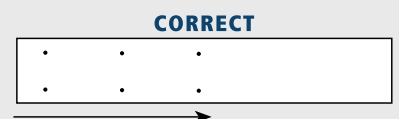

Fasten MiraTEC trim from one end to the other end.

BUTT JOINTS:

All joints must fall over a framing member.

- MiraTEC trim can be mitered, scarfed, or beveled as required.
- Use caulk or sealant on all field cut and raw ends for butt, mitered, scarfed or beveled joints.
- For runs less than 30 feet in length, butt joints should lightly touch.
- For runs over 30 feet in length, space all butt and scarf joints 1/8" apart and apply sealant into the full depth of the 1/8" joint.
- Double nail all joints on both sides as noted in the diagram.

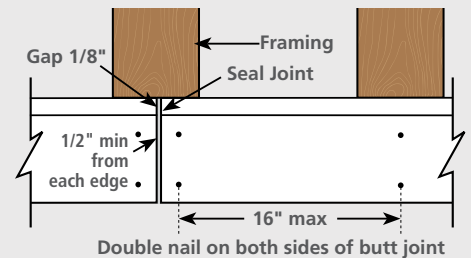
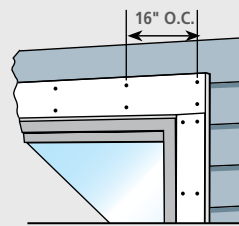

Glue Mitered Edges

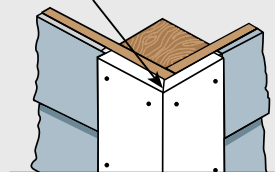

When mitering for column wraps or corner boards, we recommend gluing the edges of the trim to maintain a tight joint. We recommend a high quality exterior grade yellow carpenters glue or high quality polyurethane adhesive. Lightly ease the edge of the finished corner with 220 grit sand paper for best paint adhesion.

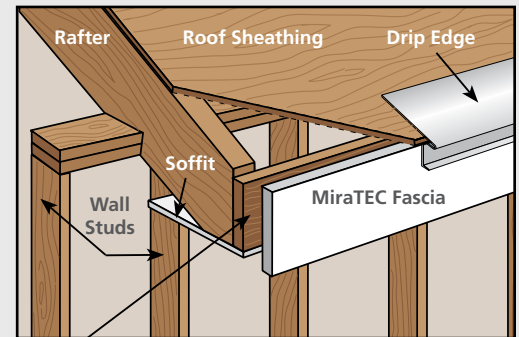
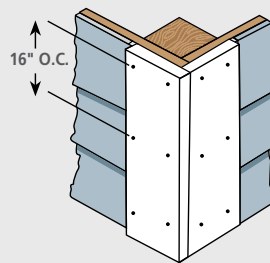

Subfascia is recommended in regions of high humidity or extreme humidity changes and required when using 5/8" MiraTEC trim

FASTENERS:

Always use fasteners appropriate to the style of construction where the trim is installed.

- Fasteners must be equal or better in performance (such as nail withdrawal, bending strength and corrosion resistance) to 6d or 8d 16 gauge finish nails or headed nails, long enough to penetrate 1-1/4" into structural wood studs or studs and structural sheathing material.
- Use corrosion resistant nails.
- For buildings utilizing steel studs, use ET&F fasteners: AST-075 for 3/4" (4/4) MiraTEC and AST-100 for 1" (5/4) or 1-1/4" (6/4) MiraTEC.
- For specific questions related to these installations, please consult us directly by sending an email to support@miratecextira.com.

Power or pneumatic nailing systems may be used. Visit miratecextira.com for information on air pressure settings on a variety of pneumatic nailers. Tapered or bugle head fasteners are permitted when the heads are properly sealed from moisture.

Nail heads, or other dents, can be filled with exterior grade spackling putty specifically designed for filling nail holes on wood composite products. Allow putty to dry, sand smooth with 100 grit sandpaper, and spot prime before painting. Over time, spackling putty may need to be replaced or touched up. For the best aesthetic appearance when using the smooth side of MiraTEC trim, additional work is required. The nails should be set flush or slightly countersunk (not to exceed 1/8"). Then, apply the spackling putty as outlined above. Reapply the putty as needed for desired appearance.

Use a nail that is appropriate to the style of construction. **Do not use staples, brads, or t-nails.**

CONDITION		CORRECTION
Snug		OK
Flush		OK
Visible fiber		Paint
Counter sunk 1/16" - 1/8"		Exterior spackling putty
Counter sunk more than 1/8"		Exterior spackling putty & add nail



ADHESIVES:

Glues or adhesives can be used on MiraTEC trim, such as on mitered joints for outside corners or column wraps. We recommend a high quality exterior grade yellow carpenters glue or a high quality polyurethane adhesive. For a full listing of recommended adhesives visit miratecextira.com.



SEALANT:

Sealant is required at all joints and where MiraTEC trim abuts siding, windows, doors, other materials, or other MiraTEC product. We recommend caulks and sealants that meet ASTM C920. The purchaser, general contractor, installer, and others who are using or installing this product are responsible for ensuring that a proper caulk joint is installed that is compliant with the local building code, industry standards and to ensure that it coats the full depth of any joints.

- Use only exterior quality sealant that remains flexible over time.
- Do not use hard-setting caulk, Bondo® or similar hard setting fillers or putties on MiraTEC trim. They will crack over time due to the natural expansion and contraction of the trim.
- Apply caulk and sealant according to the manufacturer's written instructions.

For a full listing of recommended sealants visit miratecextira.com.



MACHINING:

MiraTEC trim can be grooved or machined to produce a variety of decorative applications.

- The machined profile should not compromise the physical integrity of the board or induce cracking or splitting of the product.
- Routed or grooved MiraTEC trim should not have any flat surfaces where water can accumulate. Maintain an angle of at least 100 degrees from the vertical to provide positive drainage and to prevent moisture from standing on the surface.
- Re-prime and paint all machined areas with a high quality exterior oil or acrylic latex primer formulated for composite wood and paint (see the Painting/Finishing Requirements section of these instructions).

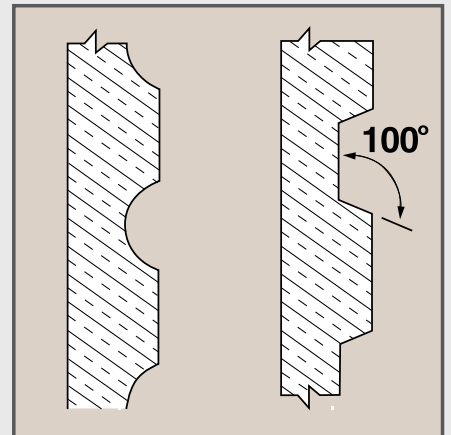

Examples of machining



FLASHING AND MOISTURE CONTROL:

The structure on which MiraTEC trim is applied should be well ventilated and dry. Do not apply MiraTEC trim over wet sheathing, or any closer than 6" to finished grade such as flower beds, mulch, or final landscaping per local building codes.

As with all wood products, MiraTEC trim should not come in direct contact with masonry or concrete. At foundations, decks, flooring, exterior brick veneer or other materials, the product should be separated from the surface by metal flashing, polyethylene film, 30 lb. felt or a 1/4" air space using masonry standoffs. In all applications, MiraTEC trim should not be allowed to stand in water or sit directly on another surface, regardless of the material:

- Seal the trim applications to prevent water intrusion.
- Do not allow water to stand on or leak behind any MiraTEC trim.
- MiraTEC trim used in a horizontal application, including window and door headers, must be properly flashed in accordance with the siding manufacturers', window manufacturers' or door manufacturers' application requirements and local building codes.

A properly installed water run-off system is required to direct water to intended drainage locations and reduce the potential for premature paint failure, staining, and potential water intrusion issues. MiraTEC trim is not a structural product and is not designed to hold the weight of gutters. Fasteners to hold the gutters in place can pass through MiraTEC trim, but must be anchored into structural framing members for structural support.

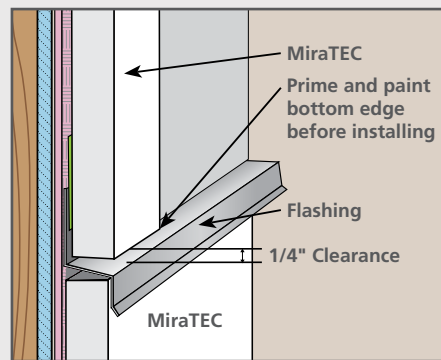
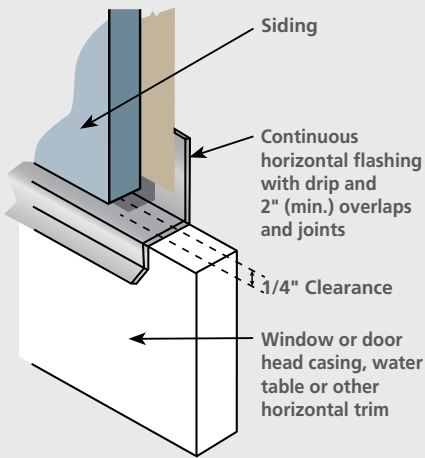

When vertical trim meets flashing at the top of trim or siding, provide a 1/4" clearance from the bottom of the trim to the top of the flashing.

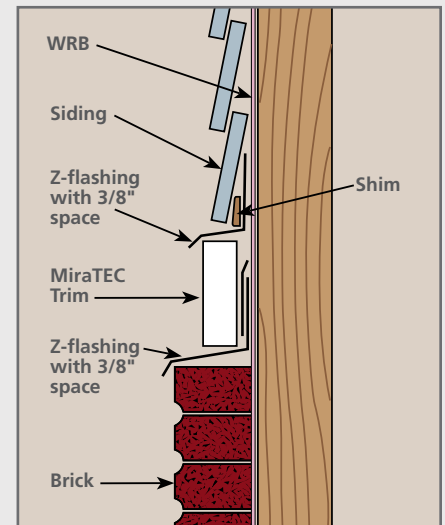

Install flashing in a manner that creates proper out-sloping.

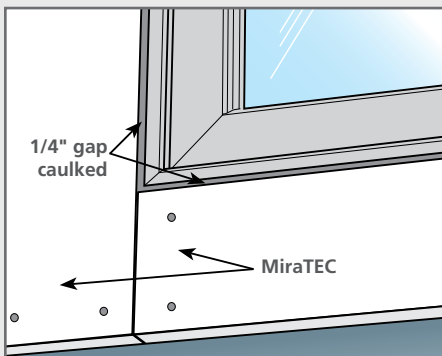

Windows:

Maintain a min 1/4" gap and fill with caulk, or backer rod and caulk, where the MiraTEC is applied next to windows. If the window installation instructions call out a different gap, then default to their published instructions.

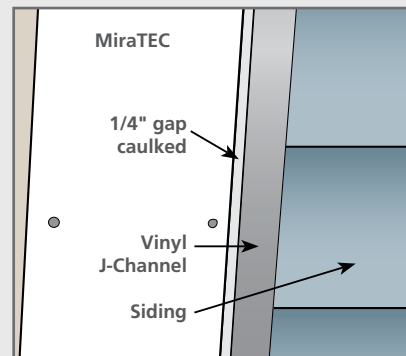

Vinyl J-Channel:

Maintain a min 1/4" gap and fill with caulk where the MiraTEC butts against vinyl j-channel. This applies for both vertical and horizontal applications of trim and j-channel. Vinyl J-Channel is not a substitute for flashing.

BOARD AND BATTEN APPLICATION:

MiraTEC trim is not approved for use as a cladding or siding product. However, the 2" MiraTEC batten product is acceptable for use in a board and batten application. 2" MiraTEC batten can be applied directly on top of the board material, including but not limited to: fiber cement products, composite wood, and other wood products.

- Battens should fall over framing members. The required nailing pattern is single nails 12" on center, staggered pattern. Nails should be of sufficient length to have 1-1/4" penetration into the framing member.
- Vertical battens do not need to be caulked. The board butt joint behind the batten should be treated per the siding manufacturers' recommendations.
- Battens can also be screwed into boards and sheathing over framing members. Screw type should be a minimum of a 6 mm head with full thread penetration into the board or minimum of 3/4" into the framing member. The required screw pattern is single screws 12" on center, staggered pattern.
- A combination of nails and glue can also be used to fasten 2" MiraTEC batten.
- Treat all other applications per the full MiraTEC Application Instructions, such as inside and outside corners, butt joints and horizontal applications.
- The vertical batten must be gapped (top and bottom) where they meet horizontal trim boards. The band board must be properly flashed.

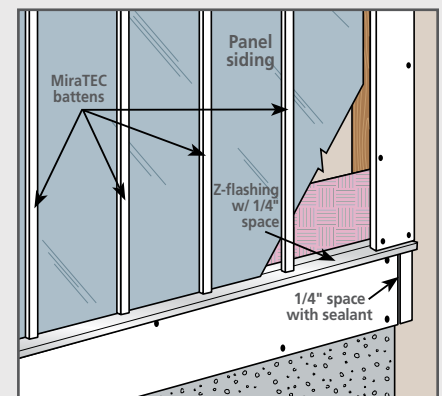
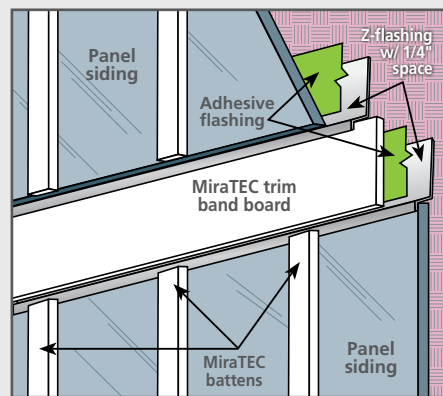
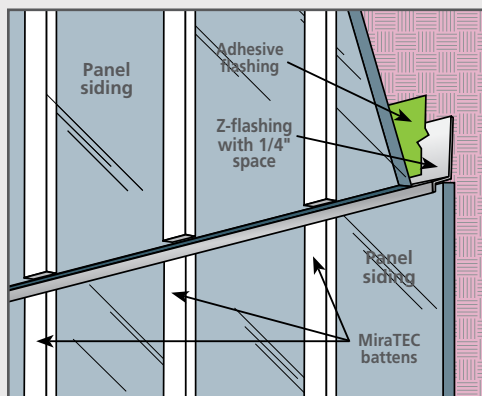
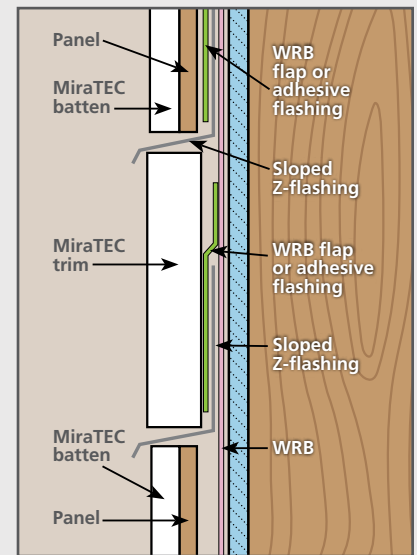
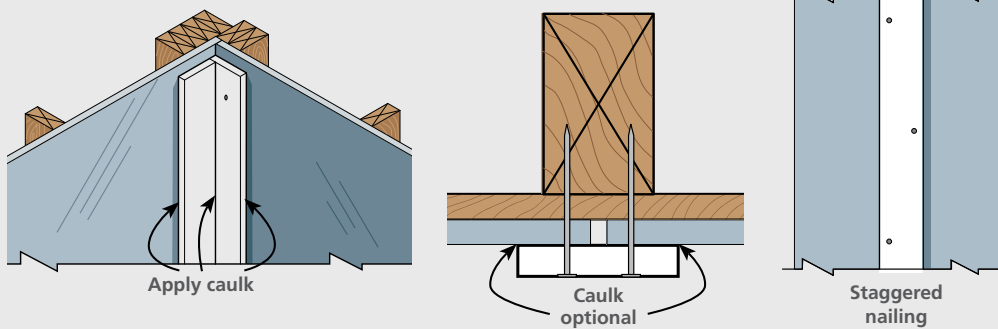

OTHER APPLICATIONS:

For applications near rooflines, such as dormer and chimneys, the trim should be installed with a minimum of 1" clearance between the roofing and the bottom edge of MiraTEC trim. At the junction of the roofing material and trim surfaces (both horizontal or vertical), flashing is required per the roofing manufacturers' application requirements and local building codes.



When facing the skirt boards on deck, properly flash the top edge to prevent water from getting behind the trim.

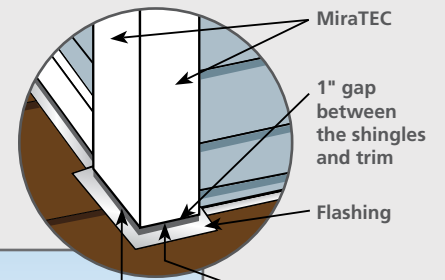
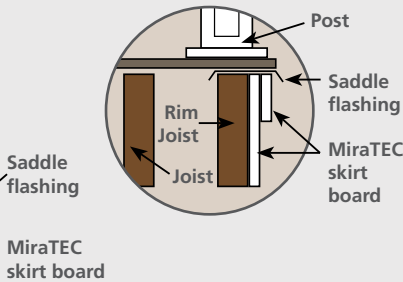

Prime and paint bottom edge before installing. Also all miter joints should be glued or caulked.

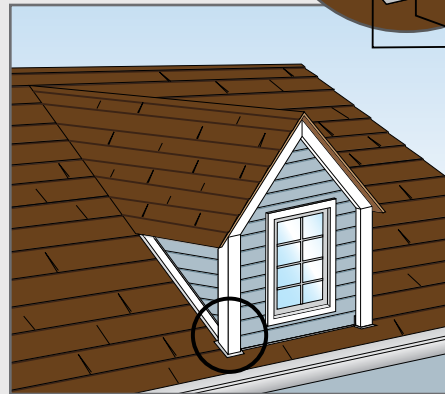

COLUMN WRAP FOR PORCH COLUMN APPLICATION

When using MiraTEC for porch column wrap applications, a 1/4" gap between the bottom edge of MiraTEC and the surface must be maintained. In installations where water might collect, a 1" gap should be created. All column base components must be flashed or sloped a minimum of 100 degrees from the vertical to provide positive drainage and prevent water pooling.

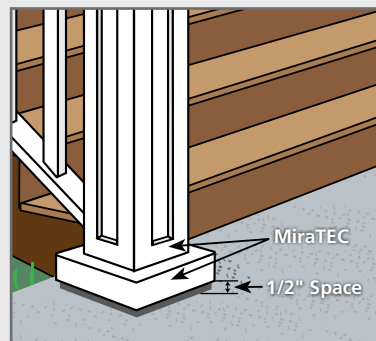
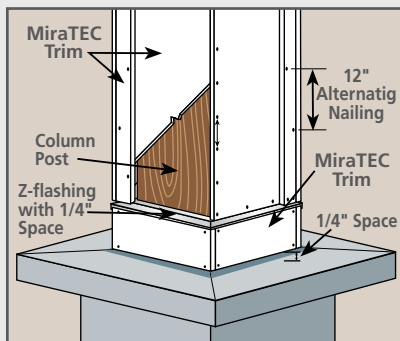

Properly flash and space at least 1/2" from any flatwork (such as porches, patios, decks, or driveways) or horizontal brick ledge. Prime and paint bottom edge before installing. Also all miter joints should be glued or caulked.

GARAGE DOOR TRIM

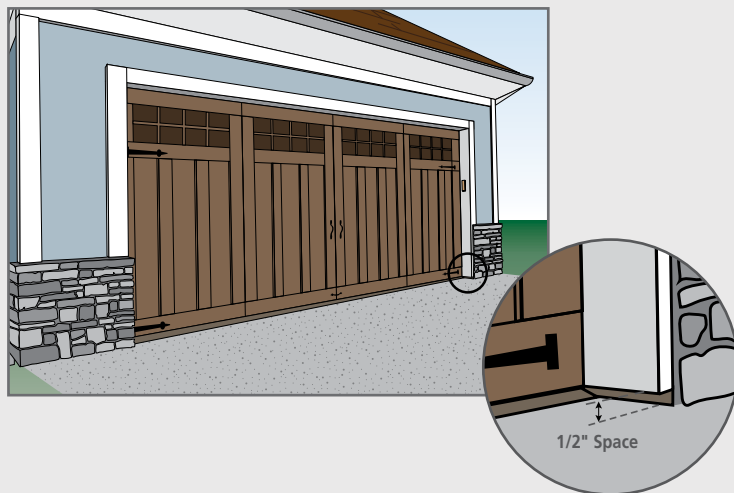

DECORATIVE SHUTTERS

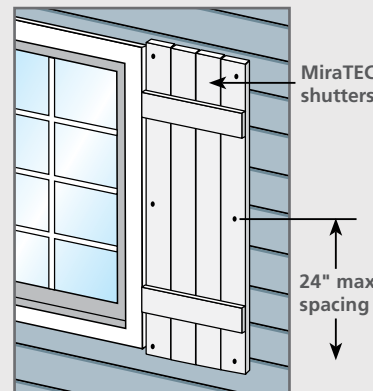

MiraTEC trim can be used to make decorative shutters. The shutter must be fastened to the home a minimum of 24" on center around the perimeter of the shutter as shown in the illustration. Working shutters are not covered by the MiraTEC limited warranty based on the inability of providing adequate fastening on the non-hinge side of the shutter.

INTERIOR USE:

Any MiraTEC used for interior applications must first be “climatized” prior to installation. “Climatization” requires that the MiraTEC be stacked in the room where it will be installed for at least 48 hours prior to installation. Each board should be separated to allow air to circulate.

SURFACE PREPARATION:

The surface to be painted must be free of dust, dirt, mildew and other foreign materials before painting. Wash with water and a mild detergent to remove dust and dirt. Allow the surface to dry before painting. If mildew is present, contact a paint supply store for recommended methods of removing and controlling mildew.

PAINTING/FINISHING REQUIREMENTS:

MiraTEC trim is manufactured from wood and must be painted with an exterior coating system in accordance with the following specifications to fulfill the limited warranty requirements.

Use a high quality exterior grade acrylic latex paint or oil/alkyd solvent based paint system recommended by the paint manufacturer for application over composite wood substrates. Always follow the paint manufacturer’s recommendations for the application and maintenance of field applied paints. The following topcoats are not recommended because of short service life, poor protection against UV light, and higher potential for performance problems:

- Shake and shingle paints
- Flat oil paint
- Clear coatings
- Vinyl acrylic paint
- Vinyl acetate paint
- Vinyl acetate co-polymer paint semi-transparent stains

Paint performance is dependent upon the quality and quantity of paint applied, and the conditions under which it is applied. Low quality paint and/or thinly applied paint tends to last for a relatively short time, resulting in discoloration, premature fading, inadequate substrate protection, and frequent repainting (sometimes as often as annually or once every two years). Top quality paint, applied in sufficient quantity, will provide the best performance with minimum maintenance. **Follow the coating manufacturer’s recommendations when selecting and applying a paint. Refer to the MiraTEC trim limited warranty for long term care and maintenance guidelines of MiraTEC trim.**

PAINT APPLICATION:

1. Prime and paint all raw and field cut ends of MiraTEC trim which will be exposed to the weather. Use a high quality exterior primer and paint formulated for use on composite wood.
2. Coat all exposed surfaces including the bottom edge.
3. Finish MiraTEC trim with two coats of paint within 90 days of installation in order to maximize the performance of the coating. If, due to unforeseen circumstances, the material is not painted within 90 days, reprime the MiraTEC trim using an exterior primer that is specifically recommended for use on composite wood products and is compatible with the topcoat to be used. Use the same primer for repair of any damage to the original factory-applied primer.
4. A total field-applied dry film paint thickness of a minimum of 2½ mils is required on MiraTEC trim. This requires the application of two or more unthinned coats of paint at the spread rate recommended by the paint manufacturer. **Note: The paint manufacturer may require a primer and topcoat combination. Follow all paint manufacturers’ recommendations.**
5. Paint performance can be impacted by ambient temperature and the time of day the paint is applied. Contact your paint supply source for more information on applying the coating for maximum results. Most companies can be contacted via a toll free number or website for specific information. Consult your retail store for information.

Prime and paint all raw and field cut ends, as well as any trim that has been machined.



We are not responsible for the performance of field applied finishes. Finish performance is dependent upon coating quality and application methods. These factors are controlled by the finish manufacturer and applicator.

NON-RECOMMENDED APPLICATIONS

MiraTEC is not recommended for applications that will encourage standing water, extended moisture contact or those providing structural support. Examples of such uses include, but are not limited to:

- Siding
- Trellis
- Planter Boxes
- Railing
- Pergolas
- Stairway components (treads, risers, stringers, etc)
- Fencing
- Deck boards

STORAGE:

Cover when stored outside. Keep MiraTEC trim off the ground and dry. Excessive moisture pickup from improper storage may affect the performance of MiraTEC trim. Do not stack material in excess of 3 units high.

For job site storage, the material should be placed on stringers and covered, preferably on concrete, asphalt, or a similar surface. For all other instances, a tarp should be placed over the ground cover under the stringers, with the material still under cover.

If trim does become wet on the job site, allow the material to fully dry before application. Do not apply trim that is wet; wet trim can shrink after application.

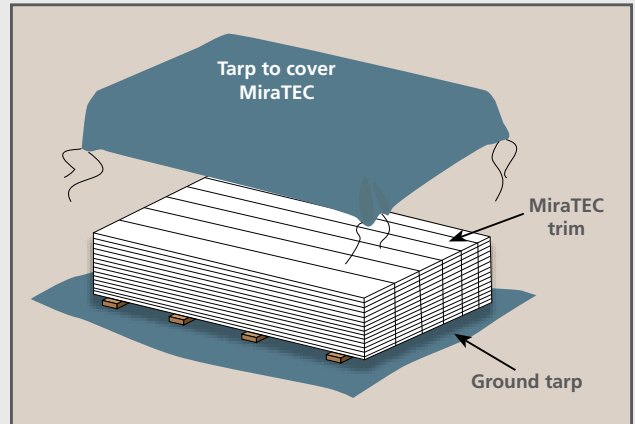

TYPICAL TRIM USES:

MiraTEC trim can be used in a variety of applications as noted below.

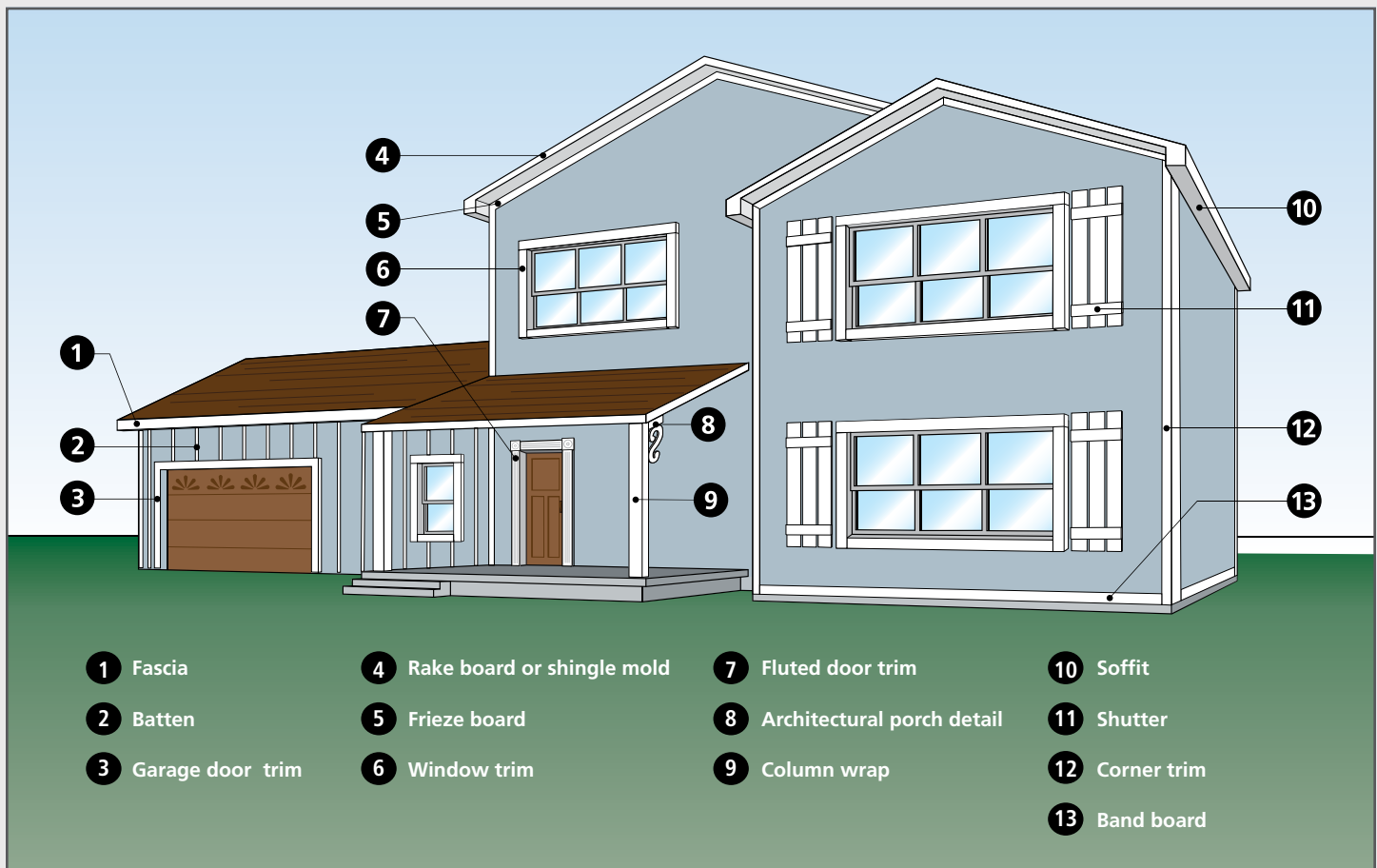

IMPORTANT: Read and understand all application instructions before installing material. The statements expressed in this technical bulletin are the recommendations for the application of the products as outlined and illustrated under normal conditions of installation. Woodgrain is a manufacturer of building materials. It does not practice architecture or engineering. The recommendations provided in this bulletin represent the company's best judgment based on its experience to date with normal applications. These instructions supplement standard building practices and building code requirements; they are not to be deemed exclusive or exclusionary of these practices and requirements. Unless prior approval is obtained in writing from the MiraTEC Product Performance Department PO Box 311, Towanda, PA 18848, any deviation from these recommended procedures shall be at the risk of the installers and may cause damage to the product itself.

These application instructions are the minimum requirements for the storage, application, and finishing of the trim products manufactured by Woodgrain. If any surface is inadequately

primed and painted or otherwise failed to be properly flashed, caulked or otherwise protected from continual moisture exposure, as set forth in the guidelines, it may lead to water intrusion and potential early deterioration or compromise of the product. Woodgrain cannot anticipate the myriad of building conditions upon which its product may be installed. Where building code requirements or standards require additional care, steps, protection or procedures, the applicable regulations must be followed. If there is a discrepancy between these guidelines and any applicable building code requirements or standards or you encounter conditions not covered by this bulletin, you must consult with a building construction professional. Consult your local representative or the Product Performance Department for conditions not covered by this bulletin. All drawings are shown for illustration purposes only and are not to scale. Adequate design and bracing of the walls, as well as compliance with these application instructions, are the responsibility of the architect, builder, applicator and painter.



WARNING: Drilling, sawing, sanding or machining wood products can expose you to wood dust, a substance known to the State of California to cause cancer. Avoid inhaling wood dust or use a dust mask or other safeguards for personal protection. For more information go to www.P65Warnings.ca.gov/wood.





LIMITED WARRANTY

EFFECTIVE JANUARY 1, 2016 TO CURRENT

MiraTEC® Treated Exterior Composite Trim Limited Warranty

This limited warranty is effective for all MiraTEC® Treated Exterior Composite Trim Products¹ manufactured on or after January 1, 2016 for use in the United States and Canada. Any previous warranties will continue to apply to products sold under the MiraTEC name prior to this date. For additional information, including care and maintenance information, refer to www.miratecextira.com.

What This Limited Warranty COVERS...

Fifty Year Limited Warranty for MiraTEC Products

We warrant to the original owner², and to two subsequent owners, that if your MiraTEC Product exhibits hail damage, delamination, decomposition of the substrate due to fungal growth, termite damage causing failure of the Product, splitting or cracking of the substrate face, buckling, excessive warping or swelling of the Product, caused by a defect in material or workmanship within **fifty (50) years** of the date of original purchase, we will pay for the replacement of the Product, limited to **twice the original purchase price*** of the failed Product according to the following schedule: We will cover prefinishing costs of replacement materials when MiraTEC is found to be defective. Verification of purchase of prefinished material is required.

Up to and including the 5th anniversary of the purchase date (Years 0-5)	200%
Years 6-10	180%
Years 11-15	160%
Years 16-20	140%
Years 21-30	120%
Years 31-40	80%
Years 41-50	40%
After the 50th anniversary of the purchase date	0%

*Prefinishing costs are excluded from doubling.

Transferability: This limited warranty is transferable up to two times to subsequent owners of the structure in which the Product is installed.

How to Get Assistance...

If you have a problem with your MiraTEC Product, immediately upon discovery, contact the distributor or dealer from whom you purchased our product or contact us directly:

Email: warranty@miratecextira.com

Phone: 888-594-3578

We can respond quickly and efficiently if you provide the following: a) date and location of purchase, b) how to contact you, c) the address where the product can be inspected, and d) a description of the apparent problem and the product (photographs are helpful).

What We Will Do...

Upon receiving your notification, we will send out an acknowledgment, usually within three business days of receipt to the contact identified. We will investigate your claim and will begin to take appropriate action within 30 days after receipt of notification. If your limited warranty claim is denied, we may charge an inspection fee for an on-site inspection that is required or requested by you.

If your claim is accepted, and we choose to repair or replace the Product or a component of the Product, the replacement Product/component will be provided in the same specification as the original Product. For factory prefinished Products replaced beyond 15 years after the purchase date, we will provide a primed replacement Product. Replacement Products, components and services are warranted for the balance of the original product or service limited warranty, or 90 days, whichever is longer.

What This Limited Warranty Does NOT Cover...

We are not liable for damage, product failure or poor product performance due to:

- Normal wear and tear, and natural weathering of surfaces or variations in the color or texture of field-finished coating; surface cracks that are less than 1/32" in width and/or 1" in length.
- Exposure to chemicals (e.g. brick wash), a harsh environment (e.g., airborne pollutants, or prolonged contact with or immersion in liquid water), or direct contact with soil.

- Misuse, abuse or failure to properly store, handle, finish and provide maintenance for the Product.
- Alteration or modification of the Product.
- Any cause beyond our reasonable control (e.g. fire, flood, earthquake, other acts of nature, and acts of third parties outside of our control).
- Problems related to: improper field finishing of all exposed surfaces and edges of the Product (See our instructions at www.miratecextira.com); variation or unsatisfactory results in sheen or texture resulting from the field application of paint or any other coating material.
- Warp or buckling less than 1/4" per linear foot; warp due to movement of any underlying materials or structures to which the Product is attached.
- Flaws in structural design and construction; installation into a condition that exceeds product design standards and/or is not in compliance with building codes.
- Hardware or accessories that are not provided by us.

We are also not liable for:

- Cost for labor, removal or disposal of defective product(s), freight, taxes or any other charge related to a failed product, installation or finishing of replacement panels.
- Incidental or consequential damage. Some states/provinces do not allow the exclusion or limitation of incidental or consequential damages, so this may not apply to you.

IMPORTANT LEGAL INFORMATION -- PLEASE READ THIS CAREFULLY. IT AFFECTS YOUR RIGHTS.

This Limited Warranty document sets forth our maximum liability for our products. We shall not be liable for special, indirect, consequential, or incidental damages. Your sole and exclusive remedy with respect to any and all losses or damages resulting from any cause whatsoever shall be as specified above. We make no other warranty or guarantee, either express or implied, including implied warranties of merchantability and fitness for a particular purpose to the original purchaser or to any subsequent user of the Product, except as expressly contained herein. In the event state or provincial law precludes exclusion or limitation of implied warranties, the duration of any such warranties shall be no longer than, and the time and manner of presenting any claim thereon shall be the same as, that provided in the express limited warranty stated herein. This Limited Warranty document gives you specific legal rights, and you may have other rights that vary from state/province to state/province.

Any dispute, controversy or claim arising out of or relating to this limited warranty, any alleged breach thereof, or the use or sale of the products to which this limited warranty applies shall be resolved by mandatory and binding arbitration administered by the American Arbitration Association in accordance with its commercial arbitration rules. Original purchaser agrees that they may assert claims against Woodgrain in their individual capacity only, and not as a plaintiff or class member in any purported class action proceeding. The limited warranty provision herein shall be interpreted in accordance with the laws of Idaho (excluding Idaho's conflict of laws principles). If any provision of this limited warranty is held illegal or unenforceable in a judicial proceeding, such provision shall be severed and shall be inoperative, and the remainder of this limited warranty shall remain operative and binding on the Parties. Rejection of these dispute resolution provisions must be sent to Woodgrain at the address provided herein within thirty (30) days of original purchaser's receipt of the Products to which this limited warranty applies.

No distributor, dealer or representative of MiraTEC Products has the authority to change, modify or expand this limited warranty. The original purchaser of this Product acknowledges that they have read this limited warranty, understand it, and are bound by its terms and agrees to provide this limited warranty to the original owner of the structure into which the Product is installed.

¹ "MiraTEC Products" shall refer to treated exterior composite trim manufactured and marketed by Woodgrain under the MiraTEC brand name for use in the United States and/or Canada.

² This limited warranty extends to the original owner (original owner means the contractor/dealer/distributor/purchaser and the initial owner of the structure where the product is initially installed) and is transferable to two subsequent structure owners. The original purchaser of this product acknowledges that they have read this limited warranty, understand it and are bound by its terms and agrees to provide this limited warranty to the original owner of the structure into which the product is installed.

MIRATEC®



ANNUAL MAINTENANCE FOR EXTERIOR TRIM

MiraTEC trim is a premium, long lasting, exterior wood composite that has been engineered to provide years of satisfaction and performance when properly maintained. Annual maintenance will prolong the life of your trim and keep it looking its best. Ensure compliance with the provisions of the MiraTEC Limited Warranty – follow the 4-Point Inspection process each year and take the appropriate action(s) to prevent small issues from growing into big problems.



HOW TO GIVE YOUR EXTERIOR TRIM AN ANNUAL 4-POINT INSPECTION



1) Check the condition of caulk and sealant

Loose and cracked caulk or sealant must be removed and replaced with a good quality, polyurethane sealant. Do not use hard-setting caulk.

2) Check for the presence of mildew

Mildew is a living organism (fungus) that grows on the surface of finishes giving the paint a darkened, dirty appearance. If the trim has mildew growth, clean it off.

Do not paint over mildew without cleaning the MiraTEC trim with a mildew cleaning solution. Mildew cleaning solutions, available at local paint, lumber and hardware stores, will help retard and control this growth. The control of mildew on the surface of MiraTEC trim is a homeowner responsibility.



ANNUAL TRIM INSPECTION

3) Check the condition of painted trim

MiraTEC trim is manufactured from wood and is primed. MiraTEC trim must be painted with an exterior coating designed for use on wood trim. Periodic washing of field painted MiraTEC trim with water and mild detergent will remove accumulated dirt. Pressure-washing should be performed only with expertise and caution should still be applied. High pressure may erode surface coating and sealants. If you choose to pressure wash, reinspect for any damage.



The condition of the paint must be inspected and maintained as noted below.

CONDITION OF PAINT	ACTION REQUIRED
Good condition/unbroken	Clean and remove dirt
Thin, but unbroken finish	Clean and apply two coats of topcoat
Badly eroded, substrate showing	Clean, prime, apply two coats of topcoat
Crack, flaking, substrate exposed	Remove loose paint film, clean, prime, and apply two coats of topcoat

FINISH SELECTION

PRIMER – Use an exterior oil- or water-based primer formulated for use on wood composite products which will seal the surface and is compatible with the topcoat finish to be applied.

TOPCOATS – Use low or non-chalking exterior acrylic latex paint, low chalking acrylic or acrylic heavy bodied latex stain, or gloss or semi-gloss oil base paint. All exposed MiraTEC trim surfaces, including the bottom edges, must have two coats.

DO NOT USE –

- Shake and shingle paints
- Flat oil or flat alkyd paints
- Vinyl acetate (PVA) vinyl acrylic or vinyl acetate-acrylic copolymer paints
- Oil base transparent or opaque stains

Due to variables involved in field application of finishes, we cannot be responsible for the performance of field-applied coatings.



4) Check water drainage/diversion

Allowing water from roofs and sprinklers to run down the surface of MiraTEC trim can cause discoloration and accelerated erosion of the paint.

Locate landscape sprinklers so that water will not hit MiraTEC trim.

Appropriate action(s) must be taken to remedy any of the above noted conditions or we may deny warranty claims for any resulting damage.



1.800.255.0785 | miratecextira.com

© 2025 Woodgrain. All rights reserved. MIRATEC® is a registered trademark and THE ORIGINAL TEC TRIM and TEC are trademarks of Woodgrain. The remaining trademarks shown are the property of their respective owners. 1101 03/2025